

# AIR AID®

## INTAKE SYSTEMS

**Installation Instructions**  
**Part Number 350-199**  
**2006-07 Dodge Charger 5.7L, 6.1L**  
**05-07 Dodge Magnum 5.7L, 6.1L**  
**05-07 Chrysler 300 5.7L, 6.1L**

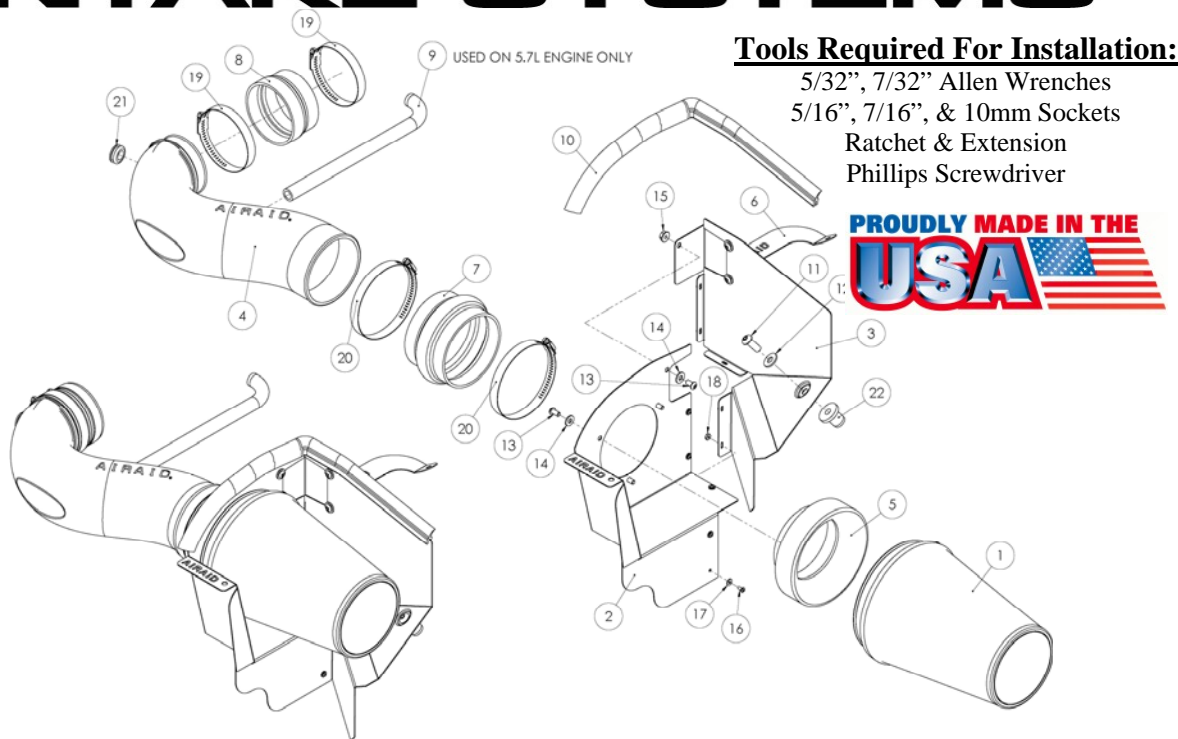

### Tools Required For Installation:

5/32", 7/32" Allen Wrenches  
 5/16", 7/16", & 10mm Sockets  
 Ratchet & Extension  
 Phillips Screwdriver

### Packing List:

#1	700-469	Airaid Premium Filter	1
#2	KIT193MAFC	MAF Panel	1
#3	KIT193BPC	Back Panel	1
#4	KIT193T	Airaid Intake Tube	1
#5	KIT112MAFADA	Filter Adapter	1
#6	KIT199RSC	Rear Support Bracket	1
#7	KITHUMPHS05	Urethane Hump Hose	1
#8	KITRDCR04	Reducing Coupler	1
#9	KITELBOW06	Breather Hose	1
#10	KITWSTRIP02	Weather Strip 20 1/2"	1
	KIT199HP	Hardware & Instructions	1
#11	KIT15BHC3100	3/8-16 x 1" Button Head Bolt	1
#12	KIT31NWUSPZ	3/8" Flat Washer	1
#13	KIT15DHC3050	1/4 - 20 x 1/2" Button Head Bolt	6
#14	KIT09FWX019	1/4" Flat Washer	6
#15	KIT1420WZZF	1/4" Serrated Nut	3
#16	KIT6C31MXPPZ	6-32 x 5/16" Screw	5
#17	KIT6NWSAPZ	#6 Flat Washer	5
#18	KIT6CNKEPZ	6-32 Keps Nut	5
#19	KITHS52	#52 Hose Clamp	2
#20	KITHS72	#72 Hose Clamp	2
#21	KITGRMT02	Grommet	1
#22	KITNUT01	Well Nut	1



**1. Disconnect the negative battery cable.**  
 If you are working on a 5.7L, first remove the engine beauty cover by lifting it up off of the grommets. Next, loosen the hose clamp that holds the factory intake tube to the throttle body.



**2. Disconnect the breather hose from the factory airbox lid.**



**3. Pull both lockdown tabs towards you on the factory airbox lid to remove the lid from the base.**



**4. Lift the intake tube towards you, and without disconnecting the wiring harness, gently remove the temperature sensor from the factory intake tube, and set it aside.**



**5. Remove the factory intake hose and lid assembly from the vehicle. Remove the factory air filter.**



**6. With a 10mm socket, remove and save the bolt that holds the factory air filter base to the radiator support. Remove the air filter base from the vehicle.**

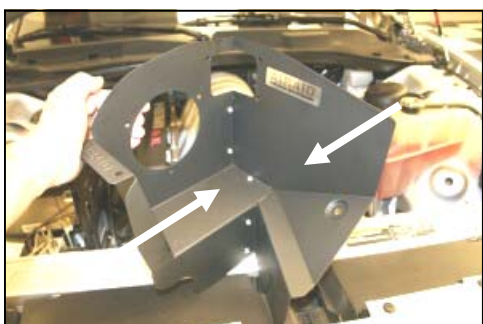

**7. Assemble the two Cool Air Dam (CAD) panels (#2, #3) using five 6-32 x 5/16" screws (#16), #6 flat washers (#17), and 6-32 keps nuts (#18).**

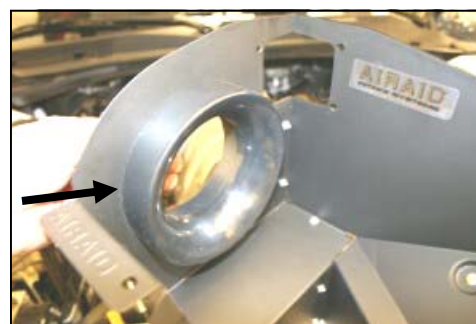

**8. Next, install the filter adapter (#5) using three 1/4 - 20 x 1/2" button head bolts (#13), and 1/4 flat washers (#14).**



**9. Slip the well nut (#22) into the hole in the inner fender.**

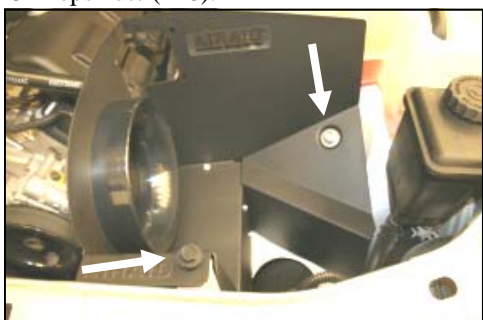

**10. Install the CAD into the vehicle. Re-install the factory bolt removed in step #6 thru the CAD and into the radiator support. Next install the 3/8-16 x 1" button head bolt (#11) and 3/8" flat washer (#12) thru the CAD and into the well nut. Tighten both bolts.**

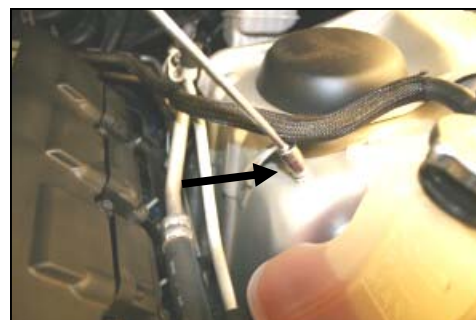

**11. Remove the 10mm nut from the stud on the driver's side inner fender and save it for the next step.**

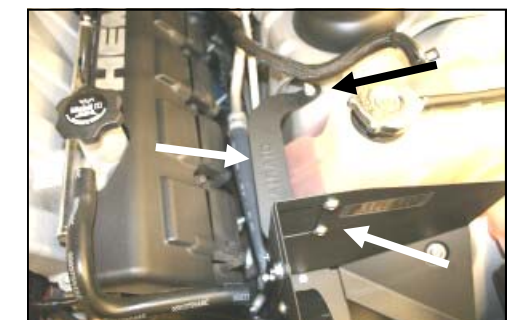

**12. Install the rear support bracket (#6) from the CAD to the inner fender using three 1/4 - 20 x 1/2" button head bolts (#13), 1/4" flat washers (#14), 1/4" serrated nuts (#15), and the 10mm factory nut removed in step #11.**

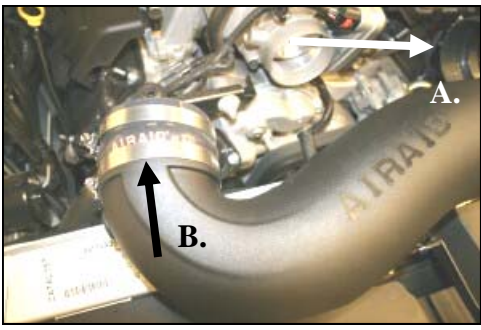

**13. A.** Install the urethane hump hose (#7) onto the filter adapter using two #72 hose clamps (#20), (*Leave loose for now*). **B.** Install the large end of the reducing coupler (#8) on the Airaid Intake Tube (#4), using two #52 hose clamps (#19). Tighten *only* the hose clamp on the tube.

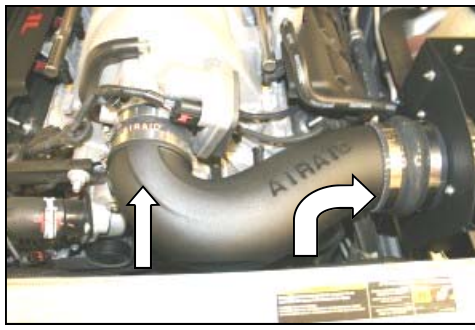

**14.** Install the Airaid Intake Tube into the hump hose first, and then onto the throttle body, making sure it is flush against the throttle body, adjust for fit, now tighten all of the hose clamps.

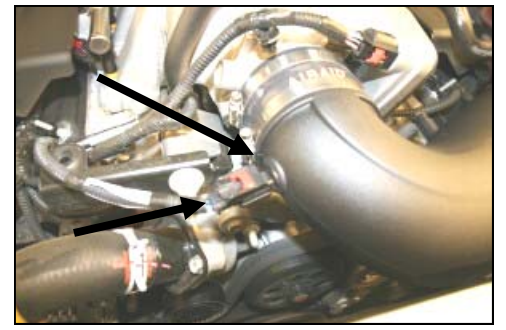

**15.** Install the grommet (#21) into the hole in the Airaid Intake Tube, and then gently push the temperature sensor (*removed in step #4*) thru the grommet until completely seated.

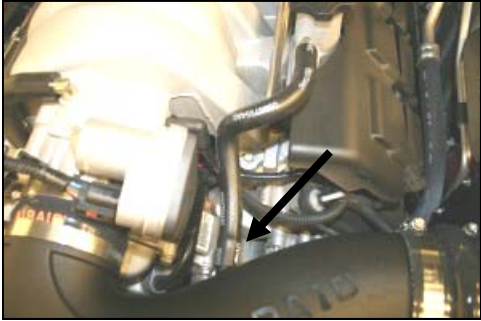

**16.** If you are working on a 5.7L, skip to step #17. If you are working on a 6.1L, re-connect the factory breather tube to the Airaid Intake Tube as shown.

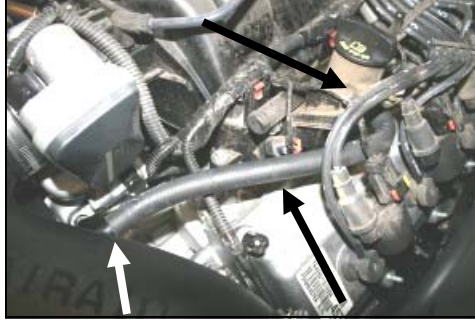

**17.** If you are working on a 6.1L, skip to step #18. If you are working on a 5.7L, install the breather hose (#9) from the valve cover to the Airaid Intake Tube as shown. Re-install the beauty cover onto the engine.



**18.** Install the Airaid Premium Filter (#1), onto the filter adapter inside of the CAD, and tighten the hose clamp. Next install the weather strip (#10) onto the top of the CAD.

**19. Double check your work!**

Make sure there is no foreign material in the intake path. Make sure all clamps, hoses, bolts, and screws are tight.

**20. Reconnect the negative battery cable!**

Thank you for purchasing the Airaid Intake System. Contact Airaid @ (800) 498-6951 8:00 AM - 5:00 PM MST weekdays for questions regarding fit or instructions that are not clear to you. Your Airaid Intake System was carefully inspected and packaged. Check that no parts are missing, or were damaged during shipping. If any parts are missing, contact Airaid. The air filter element is protected from direct exposure to water and debris; care should be taken not to drive through deep water. WATER INGESTION IS THE DRIVERS RESPONSIBILITY! The air filter is reusable and should be cleaned using the Airaid Filter Tune-Up Kit periodically.

**Before!**



**After!**



**Don't Forget Your AIRAID Filter Tune-Up Kit!**



P/N 790-551 Aerosol Spray  
P/N 790-550 Squeeze Spray



Instructions Revision  
Date: 06/19/07