

AIR AID®

INTAKE SYSTEMS

Installation Instructions
Part Number 510-179
2005-08 Toyota Tacoma 4.0L V-6
CAD Intake Kit



Packing List:

| | | | |
|-----|--------------|--------------------------|---|
| #1 | 700-458 | Airaid Premium Filter | 1 |
| #2 | KIT184MAFPC | MAF Panel | 1 |
| #3 | KIT184BPC | Bottom Panel | 1 |
| #4 | KITHUMPHS09 | Urethane Hump Hose | 1 |
| #5 | KIT184LFC | Left Gskt Support Frame | 1 |
| #6 | KIT184RFC | Right Gskt Support Frame | 1 |
| #7 | KITWSTRIP02 | Weather Strip 21" | 1 |
| | KIT179HP | Hardware & Instructions | 1 |
| #8 | KITHS72 | #72 Hose Clamp | 2 |
| #9 | KIT6C31MXPPZ | 6-32x5/16" Screw | 6 |
| #10 | KIT6NWSAPZ | #6 Flat Washer | 6 |
| #11 | KIT6CNKEPZ | 6-32 Keps Nut | 6 |
| #12 | KIT60C25OHCS | M6-1x25mm Hex Bolt | 1 |
| #13 | KIT09FWZ019 | 1/4" Flat Washer | 1 |
| #14 | KIT20CSCZ160 | M8x1.25x16mm Hex Bolt | 2 |
| #15 | KIT25NWUSPZ | 5/16" Flat Washer | 2 |
| #16 | KITFITTING12 | 3/16" Plastic Plug | 2 |
| #17 | KITWASH01 | Small Rubber Washer | 2 |

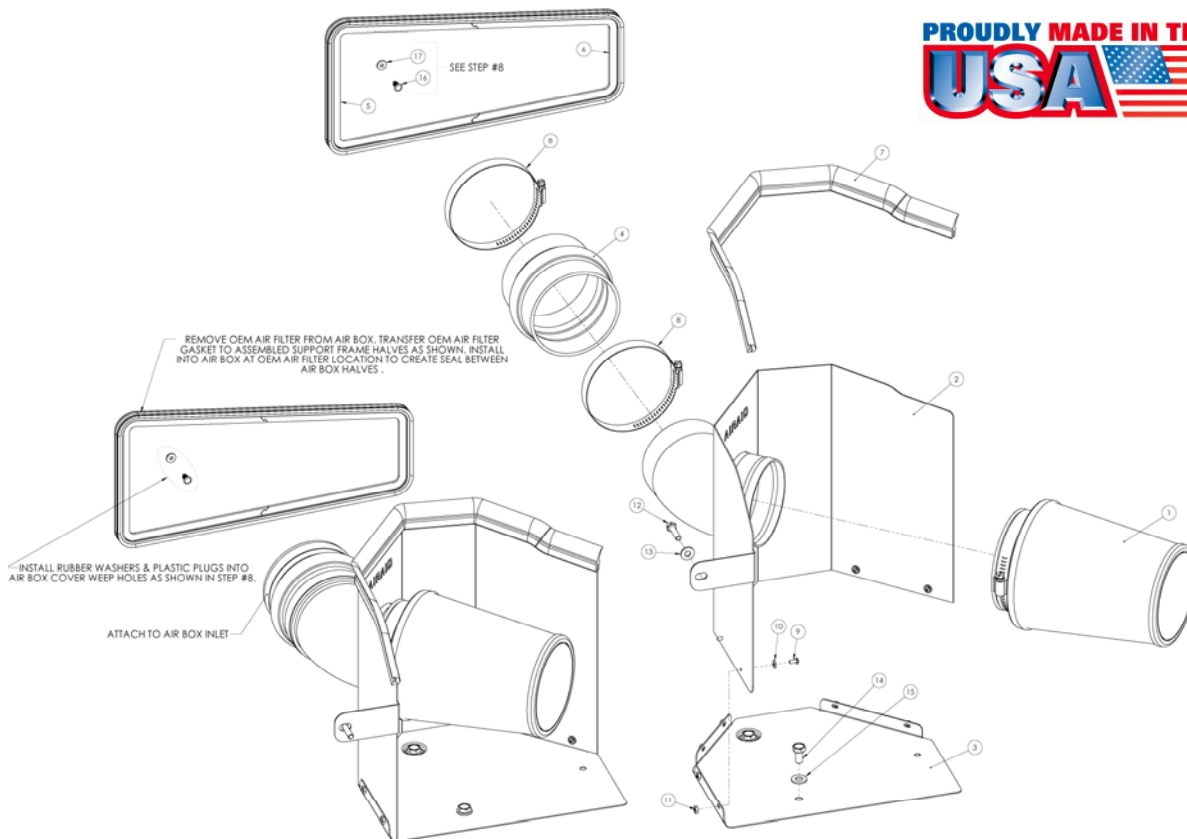

Tools Required For Installation:

5/16", 10mm, 12mm, and 13mm Sockets
Ratchet & Extension
Phillips Head Screw Driver



1. **Disconnect the negative battery cable.** Loosen the hose clamp on the factory intake tube where it connects to the airbox.



2. With a 12mm socket, remove two bolts that hold the intake tube to the fender.



3. Remove the complete intake tube from the vehicle.



4. Unlatch the two clips that hold the cover on the factory airbox and remove the cover and the factory air cleaner.



5. Remove the rubber gasket from around the factory air cleaner.

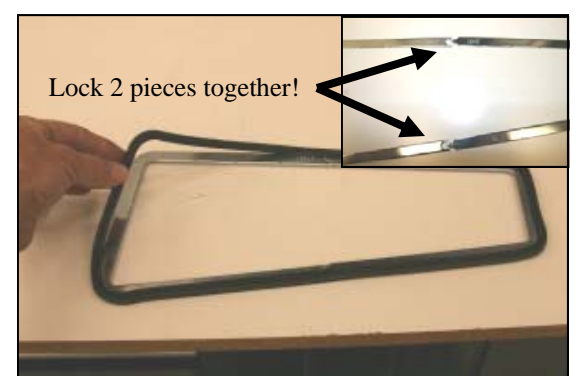

6. Lay the left and right gasket support frames (#5) & (#6) on a workbench (see inset) and re-install the factory rubber gasket around the outside as shown.

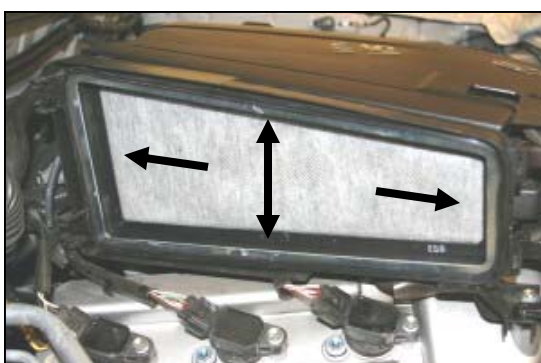

7. Re-install the gasket assembly back into the factory airbox as shown.



8. Install the two rubber washers (#17) onto the two plastic plugs (#16) that are provided in the hardware kit, and insert them into the two weep holes in the factory air cleaner cover removed in step #4, as shown



9. Re-install the factory airbox cover, and re-latch both clips.

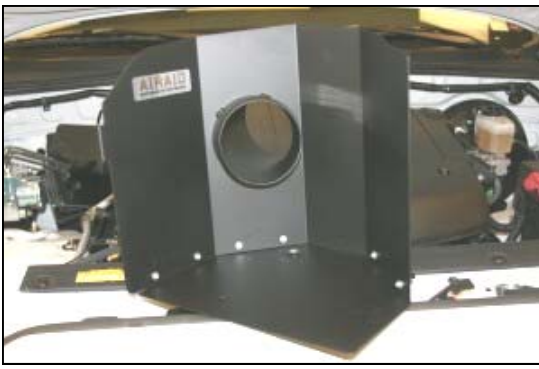

10. Assemble the Cool Air Dam panels (#2), and (#3) using the six supplied screws (#9), washers (#10), and nuts (#11), as shown.

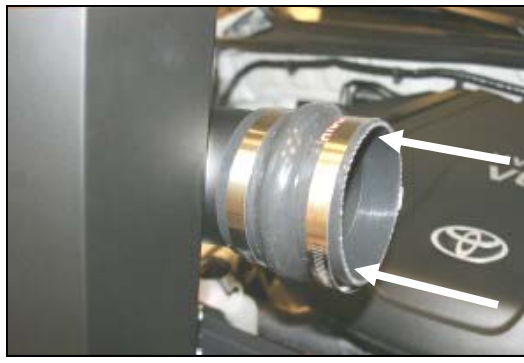

11. Install the urethane hump hose (#4), and two #72 hose clamps (#8) on the tube of the CAD as close to the panel as possible. Leave the hose clamps loose for now.

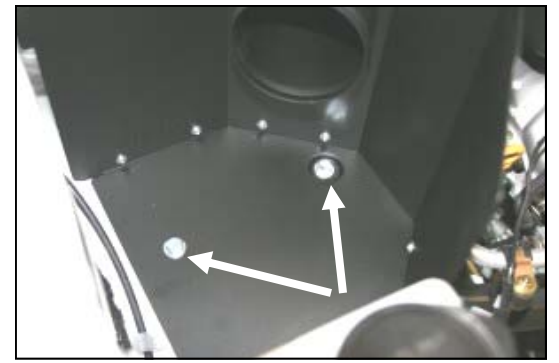

12. Install the CAD into the vehicle by aligning the hump hose with the tube on the factory airbox, and then aligning the two holes in the bottom of the CAD with the two mounting holes on the inner fender. Install the two supplied 8mm bolts (#14) and washers (#15).

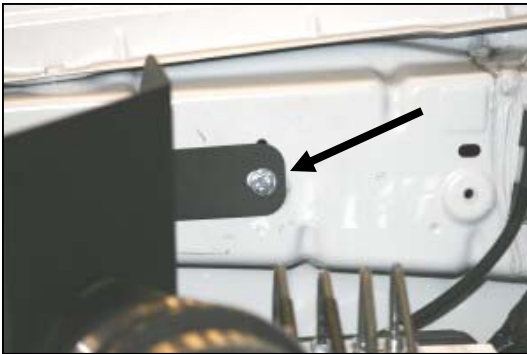

13. Install the supplied 6mm bolt (#12) and washer (#13) through the tab on the CAD and into the threaded hole in the side of the fender.



14. Center the hump hose between the tube on the factory airbox, and the tube on the CAD, adjust for fit, and tighten the hose clamps.



15. Install the Airaid Premium Filter (#1) on the CAD tube and tighten the clamp. Next install the weather strip (#7) on top of the CAD as shown. For an easier install, start at the fender side of the CAD and work your way towards the radiator.

16. Double check your work!

Make sure there is no foreign material in the intake path. Make sure all clamps, hoses, bolts, and screws are tight. Periodically check the tightness of all hose clamps. Double check the hood clearance.

17. Reconnect the negative battery cable!

Before!

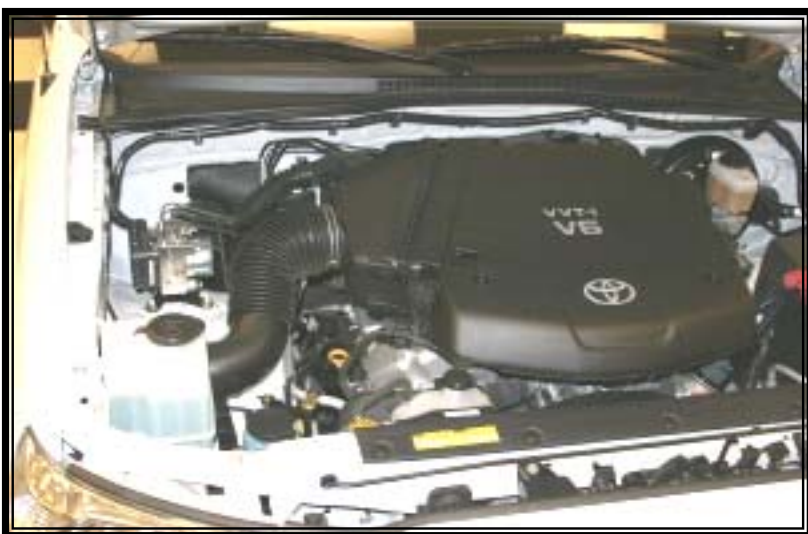

After!



Thank you for purchasing the Airaid Intake System. Contact Airaid @ (800) 498-6951 8:00 AM - 5:00 PM MST weekdays for questions regarding fit or instructions that are not clear to you. Your Airaid Intake System was carefully inspected and packaged. Check that no parts are missing, or were damaged during shipping. If any parts are missing, contact Airaid. The air filter element is protected from direct exposure to water and debris, care should be taken not to drive through deep water. WATER INGESTION IS THE DRIVERS RESPONSIBILITY! The air filter is reusable and should be cleaned using the Airaid Filter Tune-Up Kit periodically.

Don't Forget Your AIRAID Filter Tune-Up Kit!



**P/N 790-551 Aerosol Spray
P/N 790-550 Squeeze Spray**



Instructions Revision
Date: 08/23/07